

GOODWE



User Manual

Smart Energy Controller
SEC1000

V1.3-2024-07-15

1 Symbols	01
------------------	----

2 Safety and Warning	01
-----------------------------	----









3 Mounting	02
3.1 Mounting Instruction	02
3.2 Overview and Packaging	02
3.3 SEC1000 Installation	03
3.4 SEC1000 Grid Connection Diagram	07

4 Equipment Commissioning	08
4.1 Indicators and Button	08
4.2 Main functions of SEC1000	10
4.3 SEC1000 Backflow Prevention Function	11

5 Technology parameter	12
-------------------------------	----

6 Relevant Certification	12
---------------------------------	----

1 Symbols

	Caution! - Failure to observe a warning indicated in this manual may result in minor or moderate injury.		Components of the product can be recycled.
	Danger of high voltage and electric shock!		This side up - The package must always be transported, handled and stored in such a way that the arrows always point upwards.
	Product should not be disposed as normal household waste.		No more than six (6) identical packages be stacked on each other.
	CE Mark		The package/product should be handled carefully and never be tipped over or slung.
	Keep Dry – The package/product must be protected from excessive humidity and must accordingly be stored under cover.		

2 Safety and Warning

SEC1000 of GoodWe Technologies Co., Ltd. (hereinafter referred to as GoodWe) has been designed and tested strictly according to the international safety regulation. As electrical and electric equipment, Safety Regulation shall be followed during installation and maintenance. Strictly follow the installation, operation, and configuration instructions in this guide. The manufacturer shall not be liable for equipment damage or personal injury if you do not follow the instructions.

- Installation, maintenance of SEC1000 must be performed by qualified personnel in compliance with local electrical standards, regulations and the requirements of local power authorities.
- To avoid electric shock, make sure the connection between SEC1000 and AC output of inverter. SEC1000 and Grid, is disconnected before performing any installation or maintenance.
- When in operation, users should not touch any of the electrical parts of SEC1000, like internal components, cables, to avoid electric shock.
- All electrical installations must comply with local electrical standards and obtain permission from local power authorities before SEC1000 can be connected to the grid by professionals.
- Before replacing any internal components of SEC1000, the connection between the inverter and SEC1000, the power grid and SEC1000 must be disconnected, and the newly replaced components must meet the requirements of SEC1000. Otherwise, GoodWe will not assume the responsibility and quality assurance for the personal harm.
- Make sure that the AC input voltage and input current match the rated voltage and current of SEC1000, otherwise the components will be damaged or cannot work properly, and GoodWe will not assume the responsibility and quality assurance for this case.
- There are lightning protection modules inside. Make sure to connect the internal PE with the ground when installing SEC1000.
- When in operation, do not plug or unplug cables of SEC1000.
- SEC1000 must be installed out of reach of children.
- Appropriate antistatic measures should be taken.
- SEC1000 supports the three-phase four-wire grid structure only.

3 Mounting

3.1 Mounting Instruction

- SEC1000 must be installed where there is no significant shaking, shock vibration and no direct rain or snow.
- SEC1000 shall be installed at eye level for easy operation and maintenance.
- SEC1000 should not be installed near inflammable and explosive items. Any strong electro-magnetic equipment should be kept away from installation site.
- SEC1000 shall be installed at a location free from explosive hazardous media and free from gas and dust sufficient to corrode metals and destroy insulation.
- SEC1000 parameters and warning signs must be clearly visible after installation.
- SEC1000 should be installed without sunshine, rain and snow

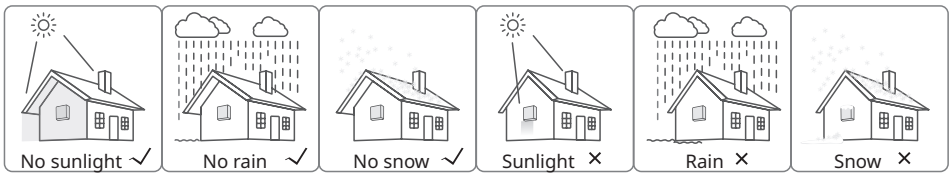

3.2 Overview and Packaging

After opening the package, confirm if it is consistent with specification of SEC1000 you purchased.

3.2.1 SEC1000 Overview

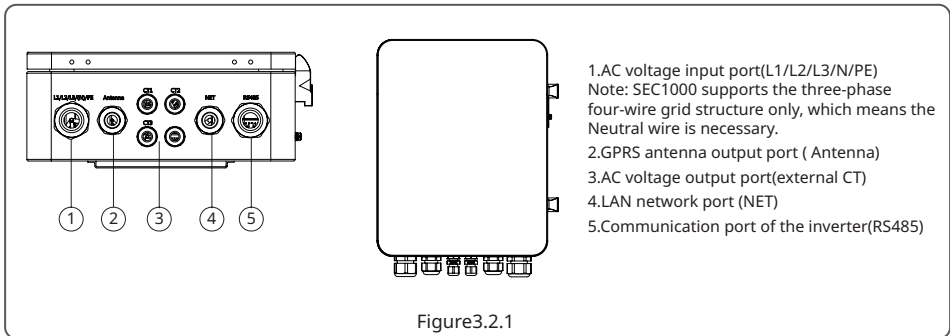
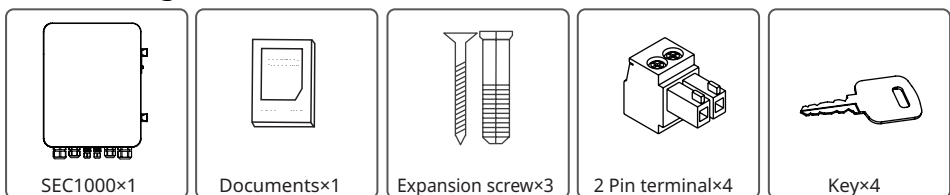
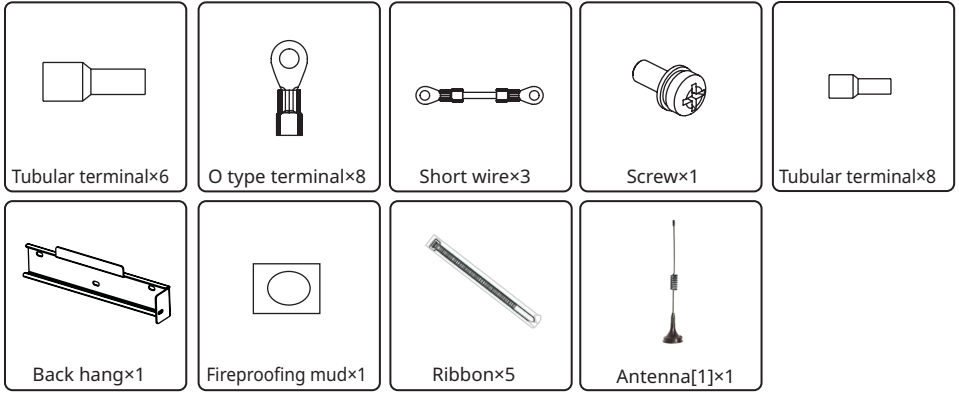

Figure3.2.1

3.2.2 Package





[1]The antenna is only for equipment with GPRS.

3.3 SEC1000 Installation

3.3.1 Selecting the installation location

The following must be considered when selecting the best location for an SEC1000

- The mount and installation method must be appropriate for the SEC1000's weight and dimensions.
- Install on a sturdy surface
- The installation location must be well ventilated
- SEC1000 can be placed horizontally or installed vertically
- The SEC1000 must be installed vertical or with a backward tilt less 15°.No sideways tilt is allowed.The connection area must point downwards.Refer to Figure 3.3.1-1.

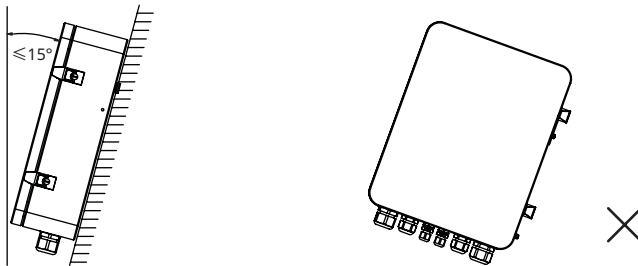

Figure3.3.1-1

- To allow dissipation of heat,and for convenience of dismantling,clearances around the SEC1000 must be no less than the values, refer to figure3.3.1-2.

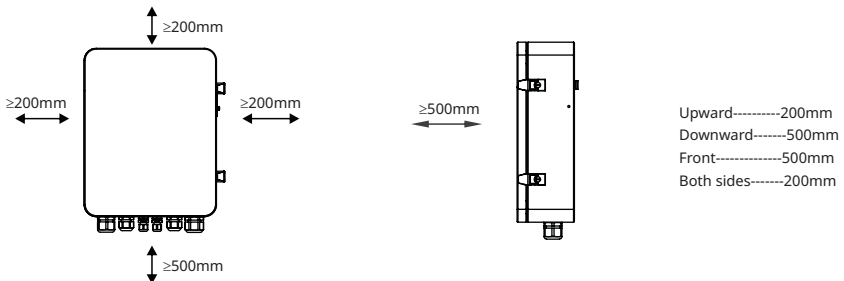
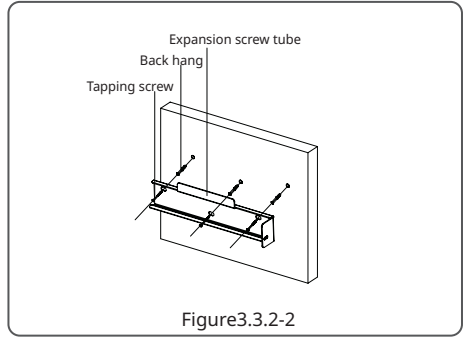
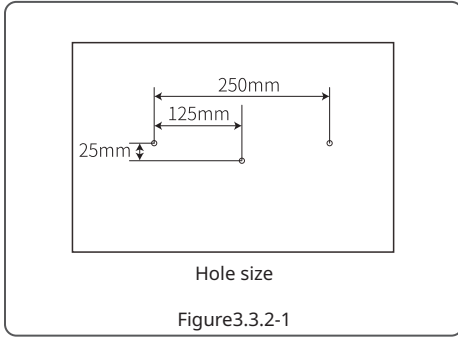

Figure3.3.1-2

3.3.2 Mounting Procedure

(1) Drill holes on the wall, 8mm in diameter and 45mm deep; Refer to Figure 3.3.2-1

(2) Fix the wall mounting bracket on the wall with expansion bolts in accessory bag, refer to Figure 3.3.3-2



(3) Place SEC1000 on the wall-mounted bracket as illustrated in figure 3.3.2-3

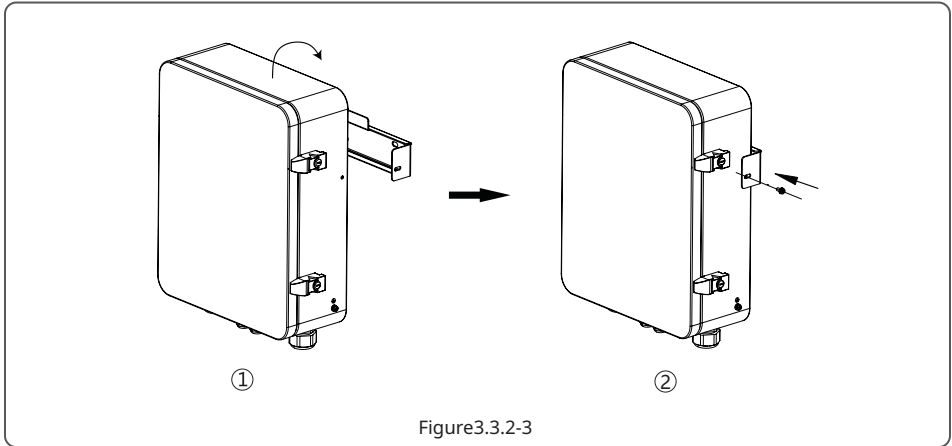

1. SEC1000 can be placed horizontally to work, as shown in the figure 3.3.2-4.

2. SEC1000 should be placed in a fixed place indoors as shown in the figure 3.3.2-5.

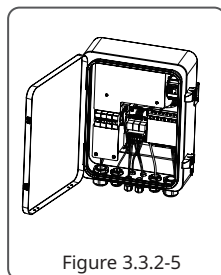
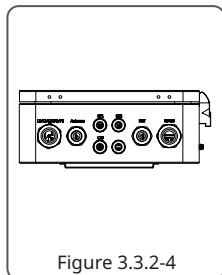

Open the door of SEC1000 as shown in Figure 3.3.2-6.

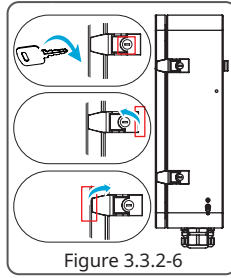
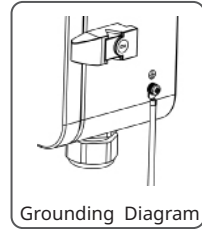

Figure 3.3.2-6

3.3.3 Port and wiring instructions

The PE cable shall be connected first when install the equipment and be disconnected last when remove the equipment.



Grounding Diagram

① Voltage Input Port(L1\L2\L3\N\PE)



Input phase voltage range: AC60V-AC280V.

Input line voltage range: AC100V-AC480V.

AC Frequency: 50/60Hz.

Sequence of the cables: PE, L1, L2, L3, N.

Specifications of the AC cable:

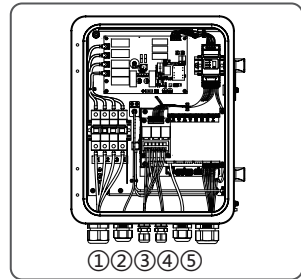

①②③④⑤

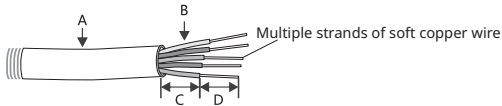

NO	Description	Content
A	Wire Diameter	No more than 25 mm
B	Cross Sectional Area of Copper Wire	R ecommend: AWG11-AWG13
C	Wire Length	About 45 mm
D	Length of Bare Copper Wire	About 12mm(10mm for PE)

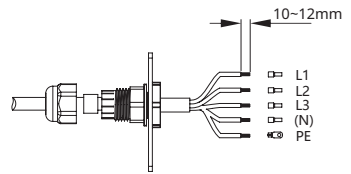

Use wire crimper to press

② Output port of the GPRS antenna

Connect the antenna to the port when installing the GPRS version SEC1000.

(As shown in figure 3.3.3-2):

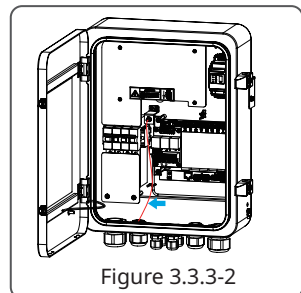

Figure 3.3.3-2

③ Current Input Port (three sets of CT)

Install three external CTs at the current input ports. Clamp the A+A-, B+B-, and C+C- of the CT to L1, L2, and L3 respectively.

Connect three sets of external CT to the connector at the position shown in figure 3-1 (A+A-\B+B-\C+C-). For detailed external CT connection, please refer to the CT connection manual.

Recommended CT

The CT with a secondary current of 5A should be prepared by customers. According to the external current range, GoodWe recommends the following specifications, for reference only.

NO	Range of current tested	Content	Remark
1	$I_{max} < 250A$	CT 200A Acrel/AKH-0.66(200A/5A)	Backflow CT,closed type(Holesize31mm*11mm, 22mm)
		CT 250A/5A Acrel/AKH-0.66-K-30x20-250/5	Backflow CT,open type(Opening size:32mm*22mm),accuracy 0.5%
		CT 250A/5A Acrel/AKH-0.66-K-60x40-250/5	Backflow CT,open type(Opening size:62mm*42mm),accuracy 1.0%
2	$250A \leq I_{max} < 1000A$	CT 1000A/5A Acrel/AKH-0.66-K-60x40-1000/5	Backflow CT,open type(Opening size:62mm*42mm),accuracy 0.5%
		CT 1000A/5A Acrel/AKH-0.66-K-80x40-1000/5	Backflow CT,open type(Opening size:82mm*42mm),accuracy 0.5%
		CT 1000A/5A Acrel/AKH-0.66-K-80x80-1000/5	Backflow CT,open type(Opening size:82mm*82mm),accuracy 0.5%
3	$1000A \leq I_{max} < 5000A$	CT 5000A/5A Acrel/AKH-0.66-K-140x60-5000/5	Backflow CT,open type(Opening size:142mm*62mm),accuracy 0.2%
		CT 5000A/5A Acrel/AKH-0.66-K-160x80-5000/5	Backflow CT,open type(Opening size:162mm*82mm),accuracy 0.2%

Specification and crimping of external CT input current wire

NO	Description	Content
A	Wire Diameter	No longer than 6 mm
B	Cross Sectional Area of Copper Wire	AWG14-AWG18
C	Wire Length	45mm(more or less)
D	Length of Bare Copper Wire	5mm(more or less)

Use wire crimper to press

④ LAN Network port

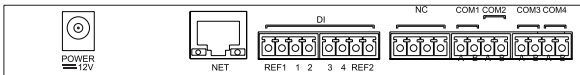

LAN SEC1000 uses this port when accessing a network cable;The access point is as shown in the "NET" position in the figure above.

It is recommended to use network cables better than Super Five Type. After wiring, use the fire-proof mud to seal the port, to ensure its protective performance.

⑤ Communication Port

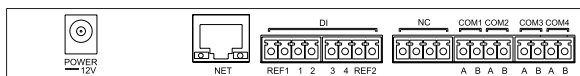

Descriptions of internal communication ports of SEC1000 are as following.

Port	Description
POWER	DC Power Input (Occupied)
NET	Ethernet Interface
DI	DRED or RCR functional interface
NC	reserve
COM1	485 interface1 with Inverter
COM2	485 interface2 with Inverter
COM3	485 interface3 with Inverter
COM4	485 interface4 with SEC1000 internal Meter(Occupied)

Wire specification and installation: It is recommended to use shielded twisted pair cables with conductor area \geq AWG14 for 485 communication cables.

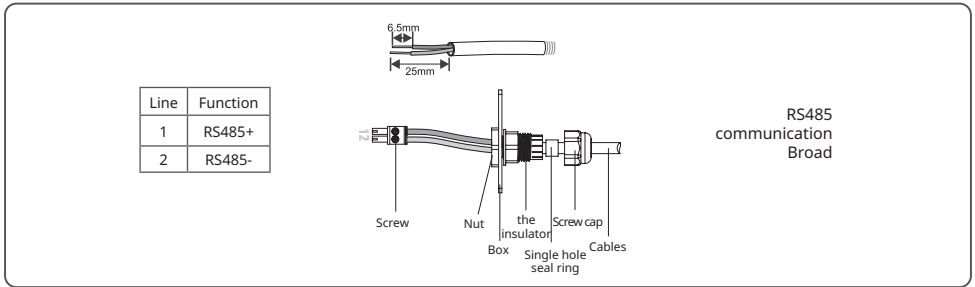



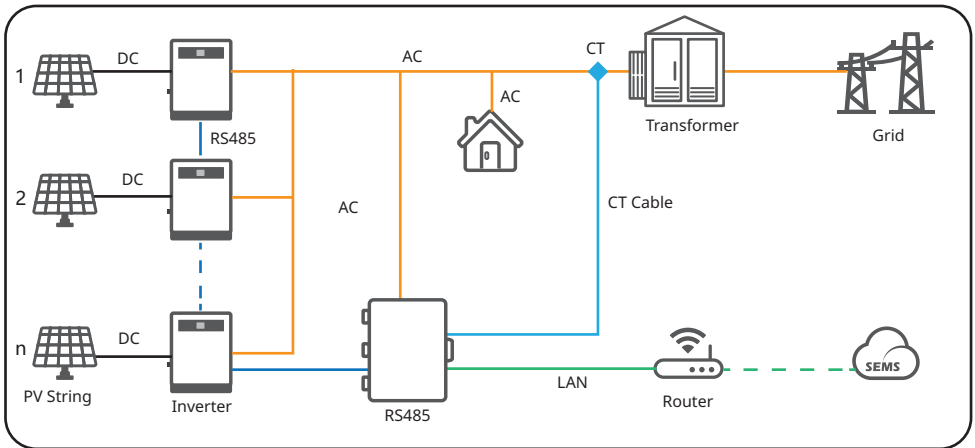





3.4 SEC1000 Grid Connection Diagram





4 Equipment Commissioning

4.1 Indicators and Buttons

Indicator	Status	Description
 POWER	Blue light On	Power supply is normal
	Blue light Off	No power supply
 RUN	Blue light flashes (1s On/Off alternately)	SEC1000 is running properly
	Blue light continue On or Off	SEC1000 is not running properly
 SERVER	Blue light continue On	EzLogger Pro can communicate with the server properly
	Blue light flashes (1s On/Off alternately)	EzLogger Pro is properly connected to the router, but not connected to the external network server
	Blue light Off	EzLogger Pro network is not connected
 PC	Blue light On	SEC1000 is connected to the computer software ProMate
	Blue light Off	SEC1000 is not connected to the computer software ProMate
 COM1	Blue light On	Number of inverters actually acquired by SEC1000 is equal to the parameter setting
	Blue light flashes (1s On/Off alternately)	Number of inverters actually acquired by SEC1000 is less than the parameter setting
	Blue light flashes (1s On and 3s Off alternately)	Number of inverters to be acquired according to SEC1000 the parameter setting is not set
	Blue light Off	No inverter data acquired by SEC1000
 COM2	Blue light On	Number of inverters actually acquired by SEC1000 is equal to the parameter setting
	Blue light flashes (1s On/Off alternately)	Number of inverters actually acquired by SEC1000 is less than the parameter setting
	Blue light flashes (1s On and 3s Off alternately)	Number of inverters to be acquired according to SEC1000 the parameter setting is not set
	Blue light Off	No inverter data acquired by SEC1000
 COM3	Blue light On	Number of inverters actually acquired by SEC1000 is equal to the parameter setting
	Blue light flashes (1s On/Off alternately)	Number of inverters actually acquired by SEC1000 is less than the parameter setting
	Blue light flashes (1s On and 3s Off alternately)	Number of inverters to be acquired according to SEC1000 the parameter setting is not set
	Blue light Off	No inverter data acquired by SEC1000

 COM4	Blue light On	Communication of external environmental monitor and other devices is normal
	Blue light Off	Not connected to external device like environmental monitor. Or the ProMate settings is not configured.

Type	Status	Description
	Steady on	Power on
	Off	Power off
	Steady on	Importing from the grid.
	Blinking	Exporting to the grid.
	Blinking	Communication is OK.
	Blinking 5 times	<ul style="list-style-type: none"> Press the Reset button for less than 3 seconds: Reset the meter. Press the Reset button for 5 seconds: Reset the meter parameters to factory settings. Press the Reset button for more than 10 seconds: Reset the meter parameters to factory settings, and reset the energy data to zero.
	Off	Meter has no communication connection.

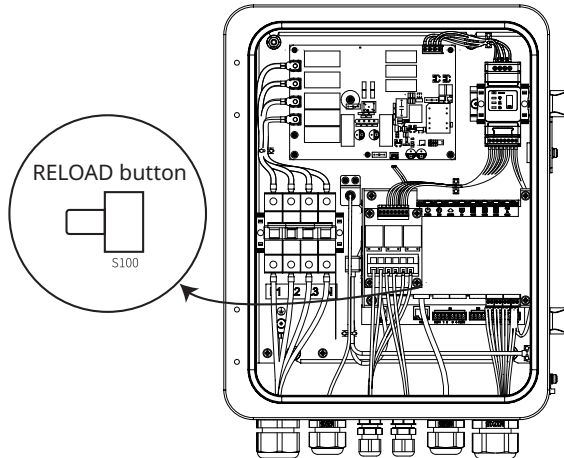

RELOAD button:

- Long press the button for 10s to switch the SEC1000 from dynamic IP mode to static IP mode. The indicator lights up from right to left after switching the mode.
- Long press the button for 3s to switch the SEC1000 from static IP mode to dynamic IP mode. The indicator lights up from left to right after switching the mode.

4.2 Main functions of SEC1000

In the Grid Connection Diagram as shown in 3.3.4(quantity of Inverter can be more than one), SEC1000 will have the functions of Active Power Regulation, and Back flow prevention, etc. The corresponding parameters of the inverter are acquired and set through the software ProMate installed in computer for monitoring and configuring SEC1000. ProMate is a kind of software that can configure Ezlogger Pro, SEC1000 etc. It can modify the network IP address of Ezlogger Pro and SEC1000, configure the number of connected inverters, time setting, RCR, DRED function, configuration and on-site debugging. First, the user need to install "ProMate" in the computer by downloading ProMate from Internet (<https://en.goodwe.com/>), Please access to the website to download the program and competethe installation. If the user needs to use ProMate software to configure SEC1000, it needs to be set in dynamic IP(DHCP) or static IP according to the network connection mode.

(1)If the user is in the dynamic IP mode, he/she only needs to connect the SEC1000 NET port to the Router LAN port with the network cable to connect to the network, namely plug and play.

(2)If the user has a static IP, it is necessary to switch SEC1000 to the static IP mode. That is, press the Reload key for about 10 seconds to reset and restart SEC1000, About 10 seconds after pressing the Reload button, the LED lights on the SEC1000 internal Ezlogger Pro Panel will blink from right to left and reset and restart.

After restart, SEC1000 will be switched to static IP mode(default IP:192.168.1.200), then use cables to connect SEC1000"NET" port to the Ethernet port of the computer.At the same time, the IP address of the computer needs to be modified. The IP address and the default gateway should be set at 192.168.1.xxx segment ($1 \leq XXX \leq 250$ and $XXX \neq 200$). For example, the IP address can be set as 192.168.1.100 and the default gateway as 192.168.1.254.

The SEC1000 is integrated with an Ezlogger Pro. Refer to the user manual of the Ezlogger Pro to get more information about the network configurations: https://en.goodwe.com/Ftp/EN/Downloads/User%20Manual/GW_Ezlogger%20Pro_User%20Manual-EN.pdf.

The interface of Promate is as follows:

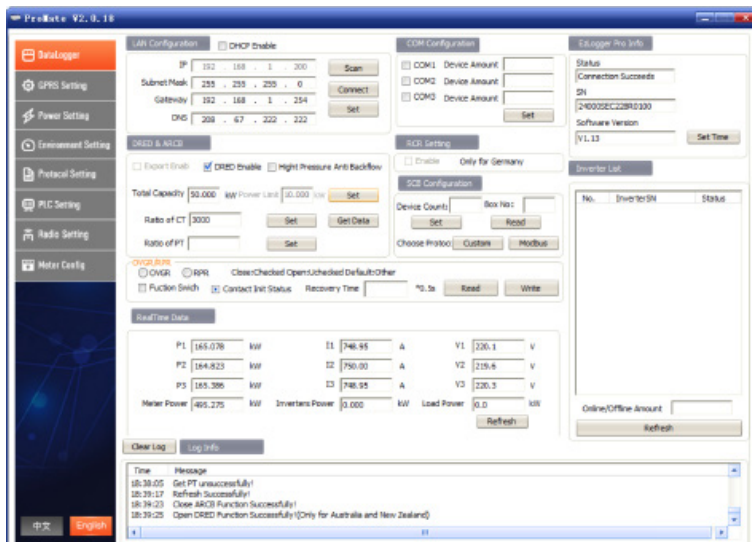

Note: The RealTime Data configuration is supported only when the DERD & ARCB Setting is on. Otherwise, the configuration is not displayed.

4.3 SEC1000 Backflow Prevention Function

Firstly, set the Total Capacity, Power Limit and the Ratio of CT(of external CT) , and then check the Export Enable (as shown in the figure below), so that the active voltage, current and power data can be monitored in real time.

The screenshot displays the ProMate V2.0.18 software interface. The left sidebar contains navigation options: DataLogger, GPRS Setting, Power Setting, Environment Setting, Protocol Setting, PLC Setting, Radio Setting, and Motor Config. The main window is divided into several configuration panels:

- LAN Configuration:** IP: 192.168.1.200, Subnet Mask: 255.255.255.0, Gateway: 192.168.1.254, DNS: 209.47.222.222. Buttons: Scan, Connect, Set.
- COM Configuration:** COM1 Device Amount, COM2 Device Amount, COM3 Device Amount. Button: Set.
- DRDZ & ARCD:** Export Enable, DRDZ Enable, High Pressure Anti Backflow. Total Capacity: 50.000 kW, Power Limit: 30.000 kW. Ratio of CT: 3000. Ratio of PT: [blank]. Buttons: Set, Get Data, Set.
- SCB Configuration:** Device Counts, Box No. Buttons: Set, Read.
- RealTime Data:** A table showing real-time data for three phases (P1, P2, P3) and total Meter Power and Inverter Power. Buttons: Refresh.
- Log Info:** A log window showing messages such as "Get PT Unsuccessfully!", "Refresh Successfully!", "Close ARCD Function Successfully!", and "Open DRDZ Function Successfully!".

Phase	Power (kW)	Current (A)	Voltage (V)
P1	165.076	748.95	220.3
P2	164.823	750.00	219.6
P3	165.386	748.95	220.3
Meter Power	495.275		
Inverter Power	0.000		
Load Power	0.0		

5 Technology parameter

Model	SEC1000 (Smart Energy Controller 1000)
Communication	
Max. Inverters Supported	60
RS485 interface	3
Ethernet	1*RJ45, 10/100 Mbps
Configuration	
Datalogger	Ezlogger*1
Meter	GM3000*1
Power Supply	100~280Vac, 50/60 Hz
Power Consumption (W)	≤10
Mechanical	
Dimensions (W×H×D mm)	350*460*143
Weight (kg)	6
Installation Method	Wall mounting, bracket mounting, pole mounting
Environment	
Operating Temperature Range (°C)	-25 ~ 60°C
Storage Temperature Range(°C)	-40 ~ 70°C
Relative Humidity	0-100% (non-condensing)
Max. Operating Altitude (m)	2000
Ingress Protection Rating	IP65

6 Relevant Certification







GoodWe Website

GoodWe Technologies Co., Ltd.

 No. 90 Zijin Rd., New District, Suzhou, 215011, China

 www.goodwe.com

 service@goodwe.com



340-00713-02 Local Contacts